

5.4 THE EFFECT OF SOUTHWESTERN WIND ON CHIMNEYS

In the winter months with southwestern wind, the air temperature approaches the flue gas temperature with the increase in temperature. As a result, the draft of the chimney decreases. The flue gas tries to seep through the gaps and cracks on the stove and pipes. This creates smoke in the room. On windy days, the wind speed may be higher than the flue gas velocity. In this case, flue gas rebounds occur frequently in stoves. Windy days should be announced to the public in advance to prevent stove poisoning.

Everyone should be asked to turn off their stove before going to bed. Water should never be poured into the burning ember to extinguish the stove. In this case, very toxic gases are formed.

When sleeping in the room where the stove is installed, the gases leaking from the stove and pipe cavities can cause poisoning, especially on windy days. Inversion usually occurs on days with high pressure and calm winds. On inversion days, the air temperature increases with altitude. On days with inversion it is very difficult to get a good gas intake in the chimneys.

On inversion days, the chimney is usually smoky and the gases want to go down instead of rising. It is difficult to burn in the stove. Because atmospheric conditions force the flue gas to go down, not up. Inversion occurs more frequently around low-rise houses in the city surrounded by tall buildings. Again, in a city in a valley surrounded by mountains, inversion occurs frequently in the morning and evening hours.

On inversion days, in the room where the stove is dry, having the door floor open provides a better chimney draft.

Since the polluted gases coming out of the chimney on inversion days are not dispersed in the atmosphere, it causes air pollution to increase.

Increasing polluted gases in the city air cause serious negative effects on health.

6. CHIMNEY CLEANING PRINCIPLES

Standard chimney cleaning: In standard chimney cleaning, the inner surface of the chimney is cleaned using a brush. With the powerful, well-filtered vacuum device, substances such as soot and creosote that are likely to enter the house are sucked out. This type of cleaning is effective for soot cleaning. Creosote deposits are normal for cleaning. It is not possible to clean the glaze (varnish) residues in the chimney with this method. Mechanical Cleaning: Wire brushes or special chains that rotate rapidly with an electric motor are used in mechanical cleaning. Mechanical cleaning is often used to remove hard creosote or glaze (lacquer) deposits. Mechanical cleaning is done by professional chimney cleaning teams. Improper use of mechanical tools can harm workers and chimneys. Chemical Cleaning: Chimney cleaners can perform chemical cleaning instead of mechanical cleaning or together with mechanical cleaning. With specific chemicals, creosote and glaze (lacquer) are loosened into the dense deposit and become soluble. Chemical cleaning is used by trained professional cleaners.

7. FREQUENTLY ASKED QUESTIONS

- I hear sudden poking noise on my stove or cooker!
The insulation of the product you bought is excellent. Therefore, your stove performs the sleeping process very well, depending on the type of fuel (wood). Since the insulation is good, the latches numbered 1 and 4 of your stove bring the combustion unit together with oxygen in sudden openings or closings, causing sudden puffing. If you gradually open and close the opening and closing of the sliders, this flatulence will not occur.
- Cracks in the enamel coating on my stove or cooker!
The enamel paint used in the product you have purchased is the products of the world's best enamel manufacturers. In order to use the enamel paint of your product for a long time without cracking, never fry your stove. These cracks can form when the stove goes out after frying.

Caliskan® Caliskan® Caliskan®

www.caliskanisi.com.tr



EN 12815 -2001



Çalıřkan®

302

FIREPLACE STOVE WITH OVEN

Heating Power: 6,80 kW
Efficiency: 62,79%

www.caliskanisi.com.tr

210 mm

160 mm

160 mm

160 mm

302

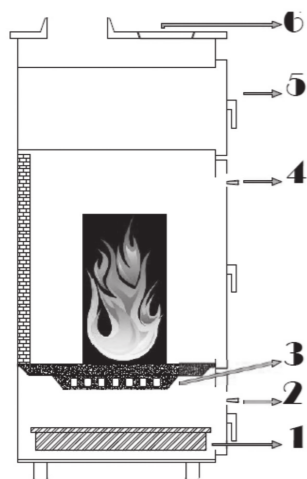

1. Ashtray
2. Bottom Air Intake Slider
3. Grid Slider
4. Window Cleaning Air Intake Spool
5. Oven Cover
6. Soot Cleaning Plate

1. USE OF THE STOVE

- Before the stove ignition process, open the 2 and 4 adjustment sliders.
- Grill and ashtray of the stove before each ignition operation must be cleaned.
- Prefer wood as fuel. Do not use coal or similar fuels.
- To ignite the stove, first of all, gasoline, kerosene and spirit do not use fuels such as
- Do not allow your stove to burn more or less, air hole number 2 You can set it by turning it on or off.
- When you open the slider number 4 on the glass cover, you will see that the soot sticking on the glass disappears. This slider, creates a current inside, creating a raw unburned it will also burn the gases.
- It should not be placed too much inside the wood burning unit. It should be left blank.
- Do not place very heavy pots or water bowls on the cast surface on the stove. Heavy items like this may cause the iron casting of your stove to collapse and crack over time.
- The body of your fireplace stove is enamelled on DKP sheet metal. It is coated. You need to burn the stove too much until you fry it. This enamel coating on it may crack.
- 600 C cast iron on the fireplace stove and its cover. Painted with durable high quality fireproof paint. This paint it may smell at first burn. In such a case, please leave your room and ventilate.
- The enamel coating used in the product you have purchased is the best in the world. They are the products of the best enamel manufacturers. In order to use the enamel coating for a long time without cracking, do not fry your stove too much. If you fry too much, cracks may occur when the stove goes out and cools.
- Do not wipe your fireplace stove with a wet cloth.
- Our fireplace stove has two air inlet sliders.
- Definitely open the slider number 2 below at the first ignition. The fresh air that will enter from here will allow your stove to ignite easily. After the fuel ignites, you can adjust the combustion level from this vent.
- Using the wire rack under the oven, your food on the tray. You can prevent gold from burning.
- There is a ventilation to remove food odors coming from the chimney inside the oven. If the smell of your food bothers you, you can open this ventilation.

2. ASSEMBLY OF THE STOVE

- The stove should be placed in a room of sufficient volume that matches the capacity of the appliance.
- The stove should be placed on a non-combustible plate that is not affected by heat, preferably on a 120°C heat - resistant material on a marble.
- In order to benefit from the heat of the stove, the stove should not be too close to the wall. The gap between the stove and the wall should be at least 50 cm.
- Do not place less than 80 cm of items around the stove. (See picture below)
- It should never be used without a chimney connection.
- The stove should be placed as close to the chimney hole as possible.
- stove pipes should be as short as possible and vertically, horizontal pipes should be laid with a slight slope to the chimney. The use of long horizontal pipes should be avoided.
- The use of too many elbows should be avoided, care should be taken not to use more than one elbow except for mandatory situations.
- Care should be taken to connect the stove pipes with each other, and air and due gas tightness should be ensured.
- The chimney to which the stove will be connected must be made in accordance with the rules and good traction must be provided.

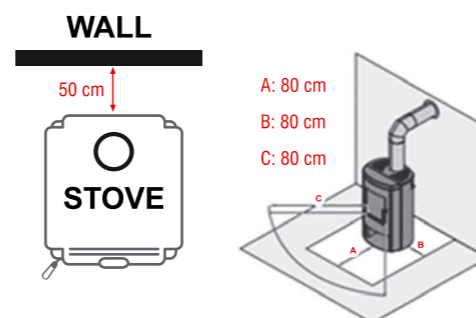

3. CLEANING AND CARE

- Never wash your stove.
- Ashes resulting from combustion will accumulate in the ashtray. The ashes accumulated in the ashtray should be regularly disposed of and cleaned after burning once or twice.
- Pipes must be cleaned at certain times in order to have proper air intake.
- Cleaning your stove frequently will increase its efficiency.
- In addition, if there are slags sticking to the inner walls of your stove, they should be cleaned from time to time.
- Never wipe the enamelled outer surface of the stove while the stove is hot.
- When the stove is dismantled after the season, clean the cast parts with any oil.
- Protect your stove from liquid and moisture by keeping it in its own package in summer.

4. MATTERS TO BE CONSIDERED

- Protect your stove from hard objects.
- Do not put very heavy material on the top cover. Do not let water come into contact with the enameled surface when your stove is shockingly hot.
- Efficient combustion of your stove can be ensured by appropriate chimney and chimney draft.
- Excessively long pipes or short elbows should be avoided.
- Make sure that the stove pipe does not enter the chimney more than 5-6 cm.
- Due to the materials used for sealing, there may be partial odor and smoke output only in the first burns.
- Place your stove on a non-combustible floor.
- Do not bring your stove closer to the wall more than 50 cm. Check frequently that your chimney is clean and not blocked.
- Ventilate the environment as soon as you feel that your chimney is not pulling. Use your stove in a place with outside ventilation. Do not use high calorie (Industrial type etc.) fuels.
- Do not let the stove glass come into contact with water when it is hot.
- Do not fry your stove in order to use tee enamel paint of your product for a long time without cracking. These cracks can form when the stove goes out after frying.

5. POISONING AND PRECAUTIONS

5.1 THE IMPORTANCE OF THE CHIMNEYPOT

- Chimney pots should be used to prevent rainwater, birds and insects from entering the chimneys and to reduce the effect of wind on the chimneys. If there is no cap in tee chimney, rain water will penetrate into the chimney and wet the chimney.
- Since there is little or no air circulation in the chimney and the sun's rays cannot penetrate into the chimney, chimneys without a cap stay humid and cold for a long time. Soot or fly ash accumulated in the chimney dissolves in a humid environment, causing a very bad smell and stains on the walls.
- Birds and insects can make nests in uncapped chimneys and cause clogged chimneys. In chimneys without a cap, flue gas rebound occurs on windy days. If the wind speed is greater than the flue gas speed, the wind prevents the gas from exiting the chimney. In houses with stoves without a cap, stove poisoning occurs frequently as a result of flue gas rebound. In order to eliminate all the problems listed above, a cap is used in the heater chimney.

WRONG

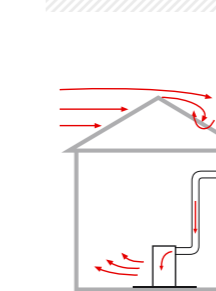

CORRECT

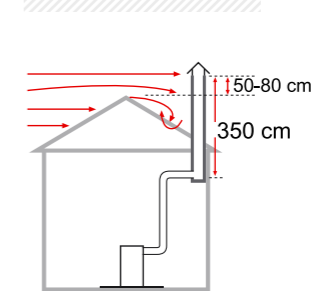

The gases in the chimney, which is difficult to rise, cause carbon monoxide poisoning in the base gas as a result of leaking into the room from defects such as cracked holes around the stove and pipe. In houses where chimneys are created from stove pipes by puncturing windows or walls, poisonings occur frequently. Therefore, in order to prevent rapid cooling of the flue gas, the chimneys should be insulated or the chimney wall net thickness should be at least 10 cm.

5.2 CHIMNEYS MADE BY DRILLING WINDOWS OR WALLS

If a chimney is created from a stove pipe by drilling a window or wall, the gases rising in such chimneys are affected by meteorological changes. One of the most important parameters affecting the rising of the gases in the chimney and throwing them into the air is the difference between the flue gas temperature. When the air gets cold and the combustion slows down in the stove, they increase their density by rapidly cooling with hot gas in the chimneys without insulation or in direct contact with the air. Since the density of cold flue gases is higher than the air at the same temperature, the gas pressure in the chimney decreases and it becomes difficult for the smoke to rise in the chimney.

WRONG

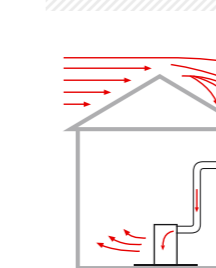

CORRECT

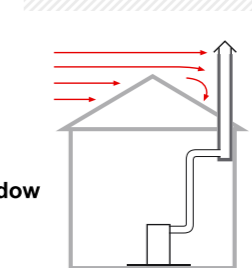

5.3 THE EFFECT OF HIGH OBSTACLES ON THE CHIMNEYS

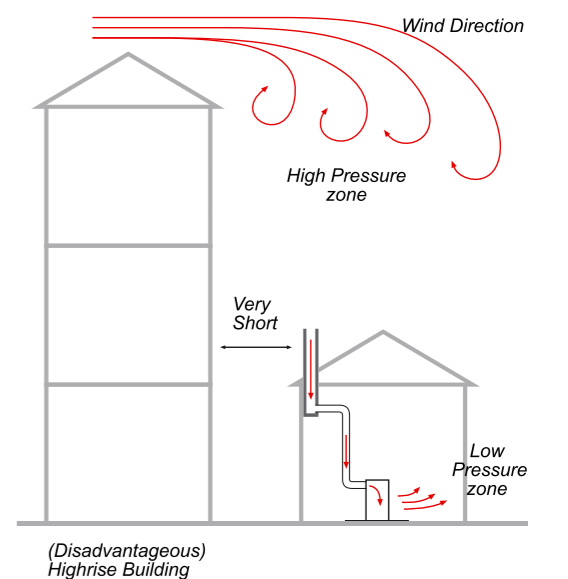

WRONG

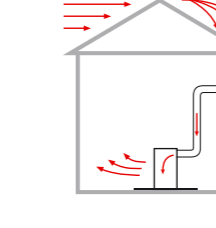

CORRECT

