

SENCEL

powered by **SENKO**

instruction manual

ELECTRIC BOILER FOR CENTRAL HEATING with or without hot water preparation



Dear customer, thank you for choosing a SENKO electrical boiler !

This product was designed and manufactured to its minutest details in order to fulfill your every need for functionality and safety.

This *Instruction manual* will teach you to operate your cooker properly, so please read the manual carefully before using the cooker.

Senko management

Table of contents

- 1. CAUTION AND SAFETY4
- 2. TECHNICAL FEATURES5
 - 2.1. EXTERIOR DIMENSIONS IN mm5
- 3. SET UP6
 - 3.1. ASSEMBLY6
 - 3.1.1 ASSEMBLY REQUIREMENTS 6
 - 3.2 SET UP PROCEDURE6
 - 3.3 PLUGINS7
 - 3.3.1 INPUT AND OUTPUT HEATING PLUGIN 7
 - 3.3.2 SAFETY VALVE PLUGIN 7
 - 3.3.3 CONNCETING THE MAINS CABLE 8
 - 3.3.4 GROUND PLUGIN..... 8
 - 3.3.5 MAIN BOLIER COMPONENTS 9
 - 3.3.6 SINGLE PHASE NETWORK PLUGIN 9
- 4. PRODUCT HANDLING10
 - 4.1. USER INTERFACE10
 - 4.1.1 MAIN MENU..... 11
 - 4.1.2 PARAMETER CHANGE 11
 - 4.1.3 DAY/ HOUR CHANGE 11
 - 4.1.4 PUMP START TEMPERATURE SETUP 12
 - 4.1.5 PARAMETER CHANGE CODE INPUT 12
 - 4.1.6 PARAMETER CHANGE 12
 - 4.1.7 HEATING SECTION CONTROL 12
 - 4.1.8 SYSTEM OPERATION MODE CHANGE 13
 - 4.2 PRODUCT OPERATION15
 - 4.2.1 CLOSET-LIKE SHEETING 15
 - 4.2.2 START UP REQUIREMENTS 15
 - 4.2.3 STARTING UP THE PRODUCT 15
 - 4.2.4 INITIAL HEATING TEMPERATURE SETUP 16
 - 4.2.5 PRESSURE CHECK 16
- 5. TROUBLESHOOTING17
- 6. MAINTAINANCE17
- 7. FREEZING PROTECTION18
- 8. ADVANCED FEATURES18
 - 8.1 SYSTEM POWER MANAGEMENT18
 - 8.2 SANITARY PREPARATION DEVICES18
 - 8.3 ADJUSTING HEATING/ SANITARY WATER MODES20
 - 8.4 WIFI CONTROL 27
- WARRANTY 38

1. CAUTION AND SAFETY

SENKO electric boiler is designed in accordance to all EN 60335-1 safety regulations. Great care has been put into designing every component keeping the customer and the worker safe from potential harm.

- Our usage, **READ** the instruction manual **THOROUGHLY**.
- Before making any action, **DISCONNECT** the boiler from all electrical outlets. Pay special attention to the electrical components, especially to bare wiring which must **NOT** exposed in order to eliminate direct contact
- Do **NOT** remove, bypass or block safety devices
- Do **NOT** modify safety devices
DO **NOT** remove, destroy or remove seals on components
- Do **NOT** make modifications to: **product** __ water and electrical outlets,
Safety valves __ Output valves

For safe and optimal operation of the device, the following devices are required, which must be provided and installed by an authorized service technician.

1 - magnetic heating circuit (impurity)

2 and 3 - placed at the inlet of cold water into the boiler, thus preventing the entry of stone and other impurities into the heating circuit as well as the domestic hot water circuit

1 - magnetic filter

2 - stone breaker

3 - sanitary water filter



In case of **non-existent** or **non-instaled** safety equipment, **HIGH RISK** of explosion which can cause **serious injury or death**

- **NEVER** maintain or repair the product by yourself, contact the SENKO service center
- In case of freezing, make sure the system stays operational. If you do not want the system operational, contact the SENKO service center to empty the system
- Regularly monitor the system pressure

- In case of **non-existent** or **non-instaled** safety equipment, **HIGH RISK** of explosion which can cause **serious injury or death**
- **NEVER** maintain or repair the product by yourself, contact the SENKO service center
- In case of freezing, make sure the system stays operational. If you do not want the system operational, contact the SENKO service center to empty the system
- Regularly monitor the system pressure

2. TECHNICAL FEATURES

Power (kW)	Current (A)	Fuse current [A]	Min heater crossection (mm ²)	Fuse type	Fid switch type
6	8,7	10	5 x 2,5	B10-3p	25/0,03
9	13,1	16	5 x 2,5	B16-3p	25/0,03
12	17,5	25	5 x 4	B25-3p	25/0,03
15	21,7	25	5 x 4	b25 3p	25/0,03
18	26,1	32	5 x 4	b32 3p	32/0,03
22,5	32,6	40	5 x 6	c40 3p	40/0,03
24	34,7	40	5 x 6	c40 3p	40/0,03
30	43,4	50	5 x 10	c50 3p	63/0,03

2.1. EXTERIOR DIMENSIONS IN mm

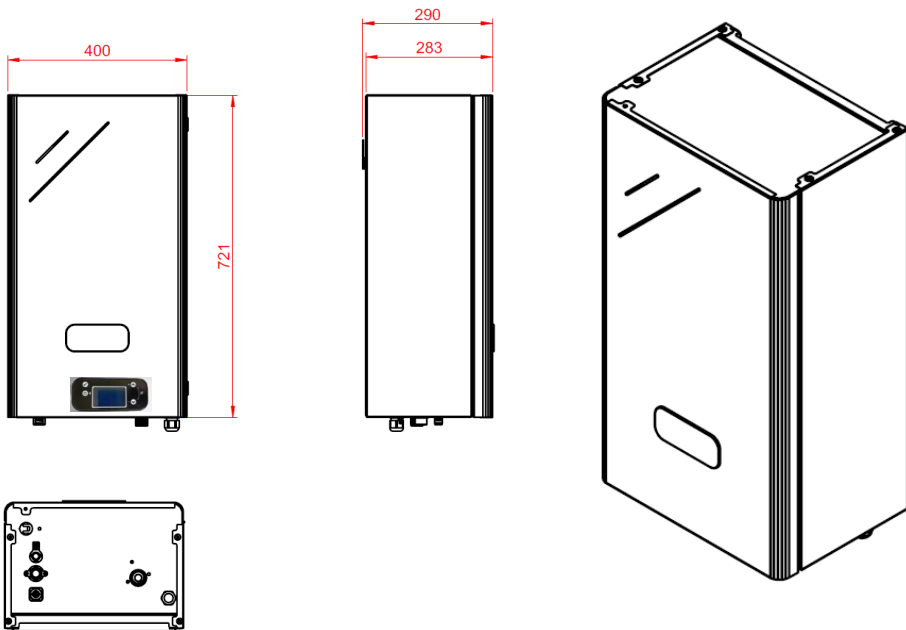

Max central heating height [m]	4	Expansion chamber volume [L]	6
Expansion chamber effective capacity [L]	3	Max chamber operating pressure [bar]	3
Max heating system pressure [bar]	3	Factory overpressure [bar]	1

A fixed setup has to be used in order to set the device in operation with the ability to cut off power from the device. This can be achieved with an automatic safety fuse or switch or any other method in accordance with local safety regulations.

If the boiler is not operational during the winter, there is a risk of freezing. In that case, fill the system with a special ant-freeze liquid for central heating systems

Recommended system pressure is 1,5 bar and the maximum pressure is 2 bar.

3.1. ASSEMBLY

3.1.1. Assembly requirements

The selected location has to ensure enough space for boiler maintenance and minimal air flow. The boiler can be set up in any room in accordance to local laws and regulations for bathroom setups. The boiler has to be set up to a flat, perpendicular wall that has to be rigid enough to sustain the weight of the boiler.

3.2. SETUP PROCEDURE

Important: two people for the setup are HIGHLY RECOMMENDED!

Attach the wall suspension using wall dowel plugs included with the device. Lift the boiler above the wall suspension, set it along the wall and put it onto the wall suspension.

Note: If the boiler is mounted on a wooden wall, **be sure** to pay attention to the weight of the boiler and use appropriate reinforcement methods in accordance to local safety regulations.

3.3. PLUGS

The boiler is considered a high-power device and thus has to use fixed electrical installations. By using fixed electrical installations, a method to cut power from the device has to be available. This can be achieved with an automatic safety fuse or switch or any other method in accordance with local safety regulations.

3.3.1. Input and output heating plugin



**Return valve
(cold water)**

**Start valve
(warm water)**

3.3.2. Boiler outlets



3.3.3. Connecting the mains cable

Note:

Before working on the boiler, cut the power and secure from accidental start.

The boiler is considered a high-power device and thus has to use fixed electrical installations. By using fixed electrical installations, a method to cut power from the device has to be available. This can be achieved with an automatic safety fuse or switch or any other method in accordance with local safety regulations. **The device has to be grounded!!**

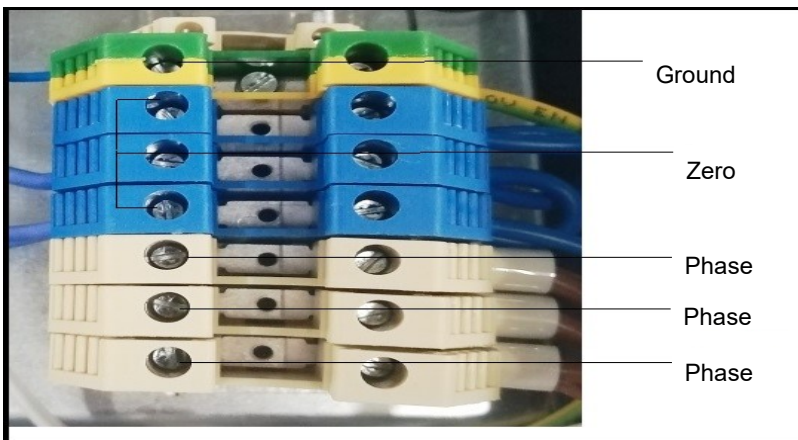

Note:

The wire has to be attached to the underside of the boiler with a special attachment. All wires in the electrical plugin space have to be tightened up.

3.3.4. Ground plugin

Ground the boiler first before doing any other action.
 Ground must never be of a smaller crosssection than all other inputs.
 Please check that all the wires are properly secured!

3.3.5. Main boiler components

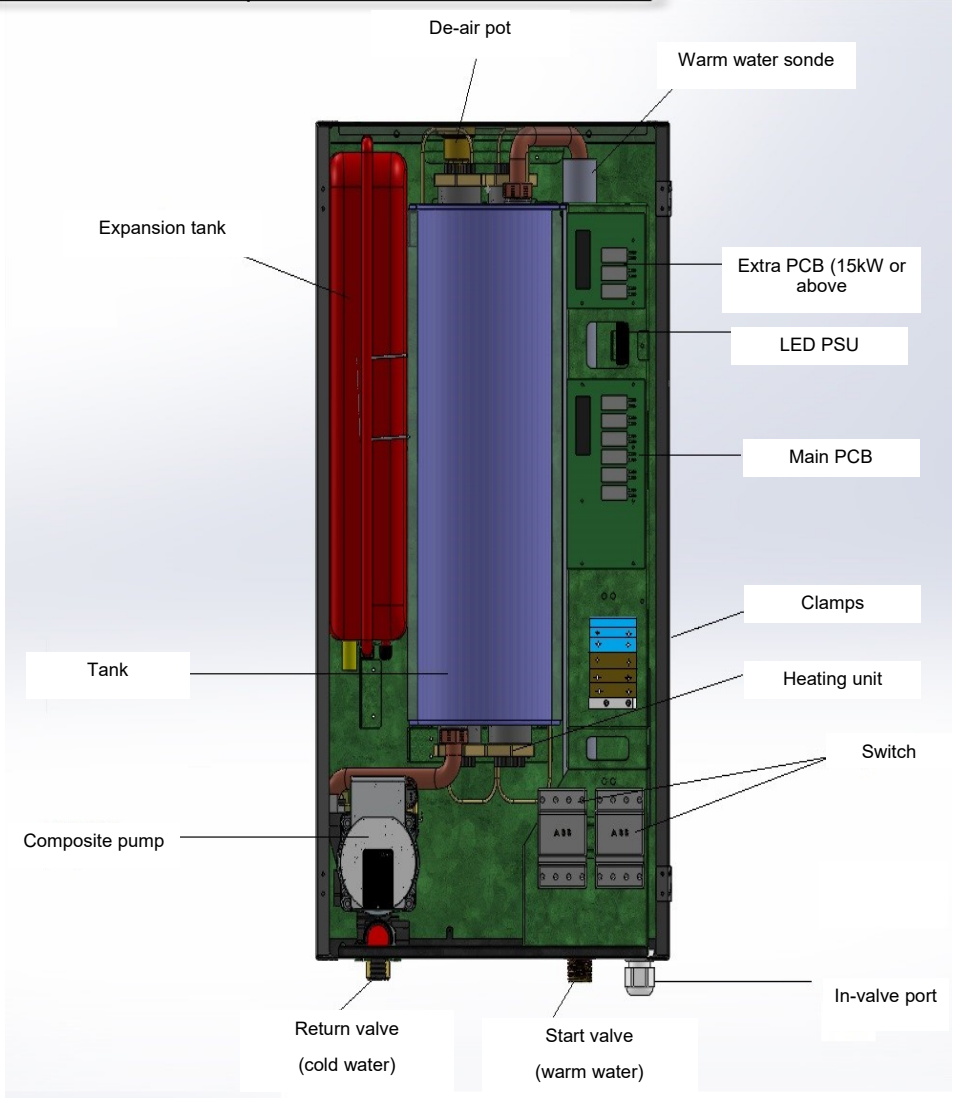

3.3.6. Single phase network plugin

Low-power devices are connected to the single phase network (6 & 9 kW)
In that case, connect via bypass.

4. PRODUCT HANDLING

UP-04 display



The display is a singular module with a graphics display and four buttons.

No	Unipel UP-04
1	„OK“ button
2	„Up“ button
3	„Dolje“ button
4	ON/OFF button
5	Display

4.1. USER INTERFACE



4.1.1. Main menu



- 1. Heating temperature settings
- 2. Parameter settings
- 3. Language options
- 4. Pump start temperature settings
- 5. Mode settings (summer, winter..)
- 6. Code input

4.1.2. Parameter change

- 1- Select simultaneously plus and minus buttons
- 2-Select „key“ icon.

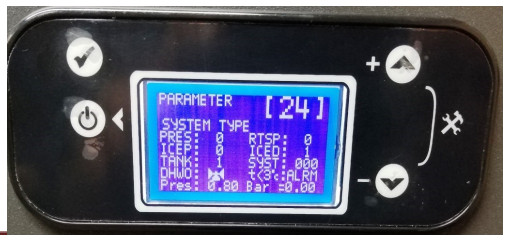

4.1.2.2 Electrical circuit

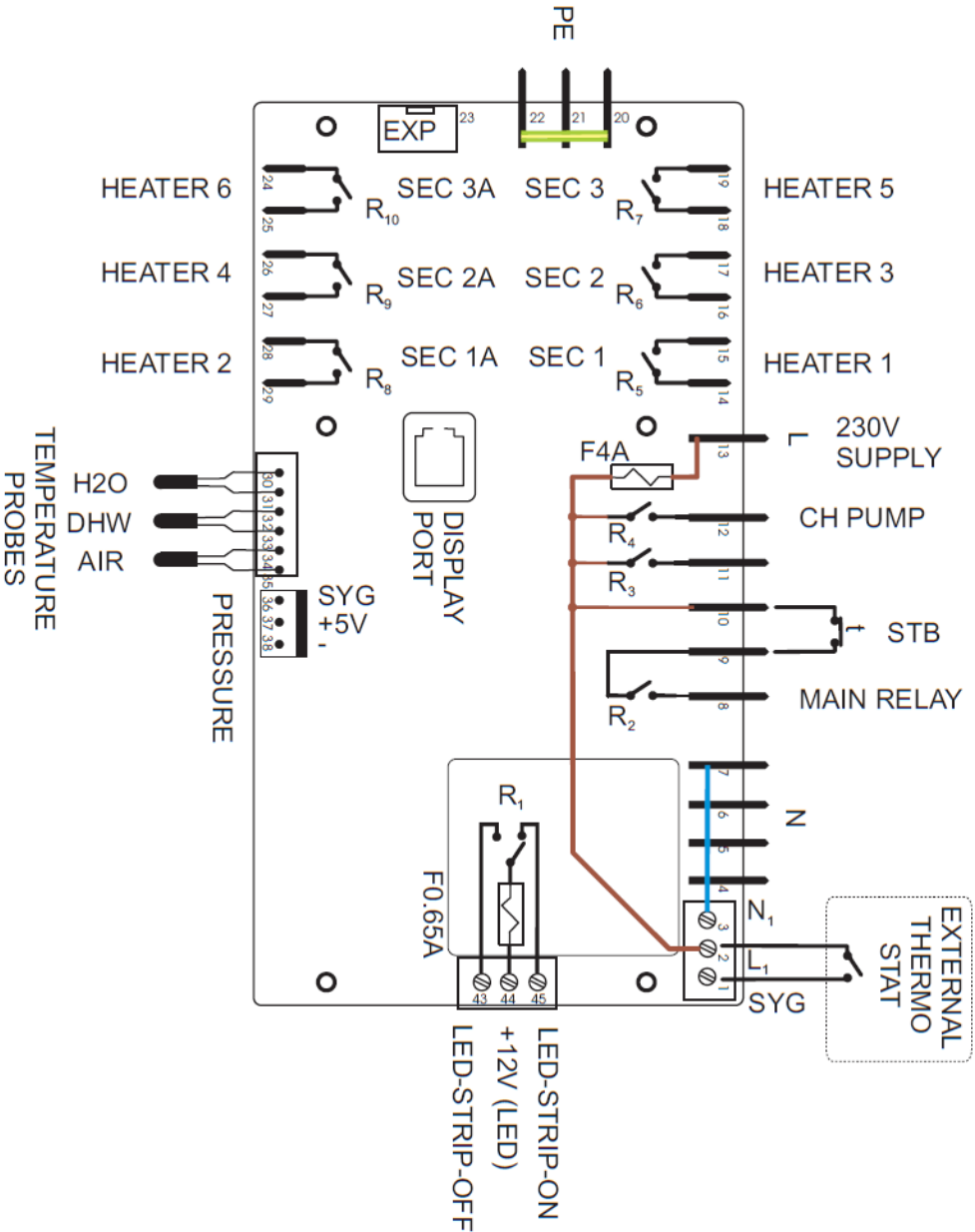

4.1.2.3 Electrical circuit /combi

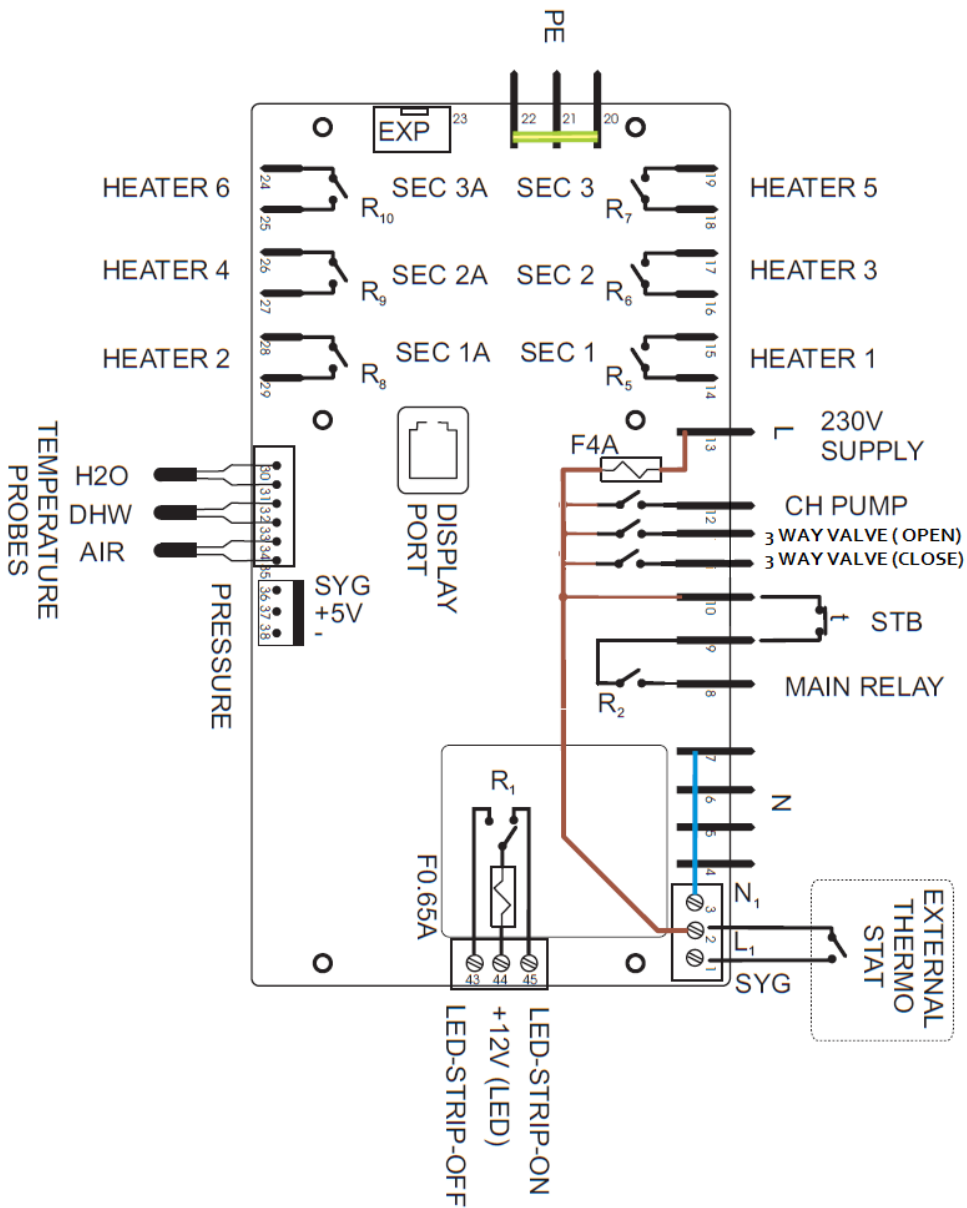

4.1.3. Day/ hour change

weekday.

The selected value will flicker; select the desired value with the „plus“ and „minus“ buttons and confirm by pressing „OK“.

Press the „OK“ button two times to select the hour (h) then again the „OK“ button to select minutes (min).

Press the „OK“ button again to select the

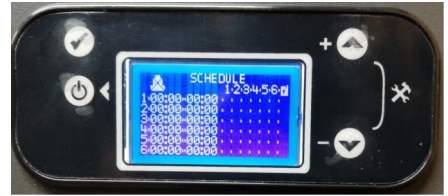

4.1.4. Pump start temperature setup

- 1– Select simultaneously plus and minus buttons
- 2– select „pump“ icon
- 3– setup



4.1.5. Parameter change code input

- 1– Select simultaneously plus and minus buttons
- 2– Select „lock“ icon



4.1.6. Parameter change

- 1– Select simultaneously plus and minus buttons
- 2– select „key“ icon.



4.1.7. Heating section control







- 1– Select simultaneously plus and minus buttons
- 2- Select „key“ icon.
- 3– Input parameter „30“



4.1.8. System operation mode change

Please make sure all settings match exactly installed heating systems. This  is very important for correct operation of all logics and priorities used.







To maximize flexibility if possible use two separate pumps for heating and hot water supply (P2).

MODE		Description
	 SUMMER	Selected element is „SUMMER“. Press OK to confirm. The symbol „  “ shows which the selected season – in this case „SUMMER“.
	WINTER	
AUTO	ANTI ICE	
STOP	ROOM TERM.	
  	DHW=P2/ 	
	EXIT	

Operation during season „SUMMER“ :

System operates according to following notes:

- Boiler temperature changes with respect to DHW's temperature settings.
- Room thermostat is ignored
- Both temperatures of DHW and boiler determine the conditions for boiler ignition/extinction.
- If DHW mode is selected as “P2”, the main pump (P1) will not be activated, only P2 is activates
- If DHW mode is selected as valve “”, the main pump (P1) will be activated together with P2. It is necessary to manually cut the circulation for heating circuit

MODE		Description
	 SUMMER	Selected element is „WINTER“. Press OK to confirm The symbol „  “ shows which the selected season – in this case „WINTER“.
	WINTER	
AUTO	ANTI ICE	
STOP	ROOM TERM.	
  	DHW=P2/ 	
	EXIT	

Operation during season „ WINTER” :

System operates according to following notes:

- Room thermostat input is used to control boiler operation

If Room Thermostat mode is selected as “TANK+ROOM TERM.”

- If DHW tank temperature goes below the DHW set value and boiler temperature is not sufficient and boiler is extinguished a new ignition is initiated no matter of room thermostat’s state.
- If DHW tank temperature reaches DHW set value and room temperature is fine (ROOM THERMOSTAT is OFF) – the boiler is extinguish no matter of boiler’s temperature

If Room Thermostat mode is selected as “STOP ROOM TERM.”

- systems’s operation is according to room temperature (ROOM THERMOSTAT’S STATE) and temperature setting of boiler.

MODE		Description
	▶ SUMMER	<p>Selected element is – „ANTI ICE”. Press OK to change this function operation state</p> <p>„AUTO/OFF” – the function is selected</p> <p>Set to „AUTO” to activate anti ice function</p> <p>Set to „OFF” to deactivate anti ice function</p> <p><i>* Function: Automatic ignition of system if temperature readed is < 5°C</i></p>
	WINTER	
AUTO	ANTI ICE	
STOP	ROOMTERM.	
	DHW=P2/	
	EXIT	
MODE		Opis
	▶ SUMMER	<p>Selected element is – „ROOM THERMOSTAT”. Press OK to change this function operation state</p> <p>STOP/TANK+” – the function is selected</p> <p>Set to :</p> <p>„STOP” to control by priority by external room thermostat</p> <p>„TANK+” to combine the operation of external room thermostat and sanitary water tank temperature .</p>
	WINTER	
AUTO	ANTI ICE	
STOP	ROOM TERM.	
	DHW=P2/	
	EXIT	

* Sets systems operation and relations between temperatures of boiler, sanitary tank and room thermostat

MODE		Opis
	▶ SUMMER	<p>Selected element is -"Type of DHW output". Press OK to change this function operation state</p> <p>“▶ ▶” - the function is selected</p> <p>Set to: “P2” if two pumps are available (P1 for circulation of heating and P2 for DHW tank”.</p> <p>“▶ ▶” systems with only one pump.</p>
	WINTER	
AUTO	ANTI ICE	
STOP	ROOM TERM.	
	DHW=P2/	
	EXIT	

If you set DHW output controls a pump (P2) the main pump (P1) can be activated independently of DHW pump output
 If you set DHW output controls un electrical valve the main pump (P1) is activated together with DHW valve output.

MODE		Opis	
	▶	SUMMER	Selected element is – „EXIT”. Press OK to go back to main menu
		WINTER	
AUTO		ANTI ICE	
STOP		ROOM TERM.	
▶ ◀▶		DHW=P2/ ◀▶	
		EXIT	

4.2. PRODUCT OPERATION

4.2.1. Closet-like sheeting

The sheeting is subject to special regulations. If you want to envelop the boiler with sheeting, contact the SENKO service center. **NEVER** do it yourself.

4.2.2. Start up requirement

Start the product **ONLY** when the doors are shut and secured with screws.

4.2.3. Starting up the product

Check if power is available to the product

- The product is ON immediately when connected. The display shows the actual initial heating temperature

Note:

In order for the anti freeze and surveillance systems stay active, it is necessary to turn on and off the device via the optional regulation device

Consult your SENKO service center.

4.2.4. Initial heating temperature setup



Select simultaneously plus and minus buttons

Select the „radiator“ icon.

Set the desired temperature

Exit the menu via the „ON/OFF“ button



4.2.5. Pressure check

For optimal system operation, cold heating system fill pressure has to be between one and two bar.

If the heating system spans multiple stories, then higher pressure may be required.

If the system fill pressure drops below 0,7 bar, on the display the pressure icon flickers.

If the pressure drops below 0,7 bar, the system shuts down.

5. TROUBLESHOOTING

Error messages have precedence over all other information on the display.

- If you encounter an error, refer to the table below.
- If your product doesn't work flawlessly afterwards, contact your SENKO service center.

Error code	Message	Description	Possible cause	Solution
-	SYSTEM OK	Everything is in good working condition, no alarms		
E1	BAD H2O SENZ	Problem detected with temperature sensor of boiler or room (depending on application HYDRO/AIR)	<ul style="list-style-type: none"> • No sensor or sensor short circuit • Defective sensor • Temperature reading extremely low or extremely high • Defective control board 	<ul style="list-style-type: none"> • Check sensor's cable and bord terminal • Check temperature by other means • Check sensor and replace if needed • Replace control bord if needed
E5	ALARM INPUT	The input for external STB is activated (no connection)	<ul style="list-style-type: none"> • Overheating 	
E7	PRESSURE	PRESSURE SWITCH IS	Pressure reading is lower than required	
E8	FROZEN	Temperature below 3°C, ignition prohibited		

6. MAINTAINANCE

- Clean the sheeting with a wet towel and a small amount of non-solvent detergent
- Dont use sprays, dish washing detergent or any cleaning products that contain solvents or chlor

7. FREEZING PROTECTION

The heating system and plumbing is sufficiently protected from freezing when the system remains operational during freezing periods and when rooms are at the required temperature.

Alternatively, the system can be emptied out. Contact your service center.

The product is equipped with an antifrost function.

When the system is plugged in and the initial temperature falls below 5°C, then the system automatically turns on and heats up the water.

7.1 TEMPORARY PUTTING THE DEVICE OUT OF OPERATION

Caution!

Property damage risk due to freezing!

The anti freezing device and the surveillance devices are only active when the product is plugged in -> DO NOT DISCONNECT!

8. ADVANCED DEVICE FUNCTIONS

8.1. SYSTEM POWER MANAGEMENT

The power regulation software controls the heating in three steps shown in three sections on the control panel

- In low power mode, section 1 is active, sections 2 and 3 are OFF (SEC1 and SEC 1A on the display)
- In medium power mode, sections 1 and 2 are active, section 3 is OFF (SEC2 and SEC 2A on the display)
- In high power mode, sections 1, 2 and 3 are active (SEC3 and SEC 3A on the display)

On the other side, the parameted describes which relays are ON or OFF for every section.

Additional panel relays stay in three pairs. Sections 1E and 2E are independant, section 3E is connected to the R10 relay on the main control panel.

Thus, if section 1 is ON, you can choose:

- Only R5 is ON
- R5 & R8 are ON
- R5 & R11+R14 are ON
- R5 & R8+R11 are ON

If section 2 is ON, you can choose:

- Only R6 is ON
- R6 & R9 are ON
- R6 & R11+R14 are ON
- R6 & R9 and R12+R15 are ON

If section 3 is ON, you can choose:

- Only R7 is ON
- R7 & R10 and R13+R16 are ON

This way, you can change the maximum power of the unit.



Status images on reduced power mode. „X“ marks status 0 or OFF, „1“ marks status „ON“ or activated.



The power of the device can be reduced in a wide range of values. Maximum reduction cannot exceed the power value of a single heater unit.

For instance, you can reduce a 30kW unit at most (the minimum 7,5kW) which is the power value of a single heater unit.

By combining the values „OFF“ and „ON“ from the picture on page 20, you can get from a 30kW unit (7,5-10,12,5-15-17,5-20-22,5-25-27,5 and 30 kW).

Using the following table, you can reduce to the desired power value by choosing the desired power value and read the image number from the table.

POWER VALUE	IMAGE NO.				REDUCED POWER VALUE kW					
	1	15	14	16	3	4	5	6		
6 kW	1	15	14	16	3	4	5	6		
9 kW	1	15	14	16	3	5	7	9		
12 kW	1	15	14	16	6	8	10	12		
15 kW	1	15	14	16	7,5	10	12,5	15		
	IMAGE NO.									
18 kW	1	2	15	3	12	7	13			
24 kW	1	5	15	3	10	16	12	7	4	13
30 kW	1	2	15	3	10	16	12	7	4	13
	REDUCED POWER VALUE kW									
18 kW	6	8	10	12	14	16	18			
24 kW	6	8	10	12	14	16	18	20	22	24
30 kW	7,5	10	12,5	15	17,5	20	22,5	25	27,5	30

8.2 SANITARY WATER PREPARATION DEVICES

SENeI electric boilers which have the ability to prepare warm water are similar in standards. Only these models, have additional components which are inevitable for function in a manner that a single unit has central heating and warm water for showers or washing hands.

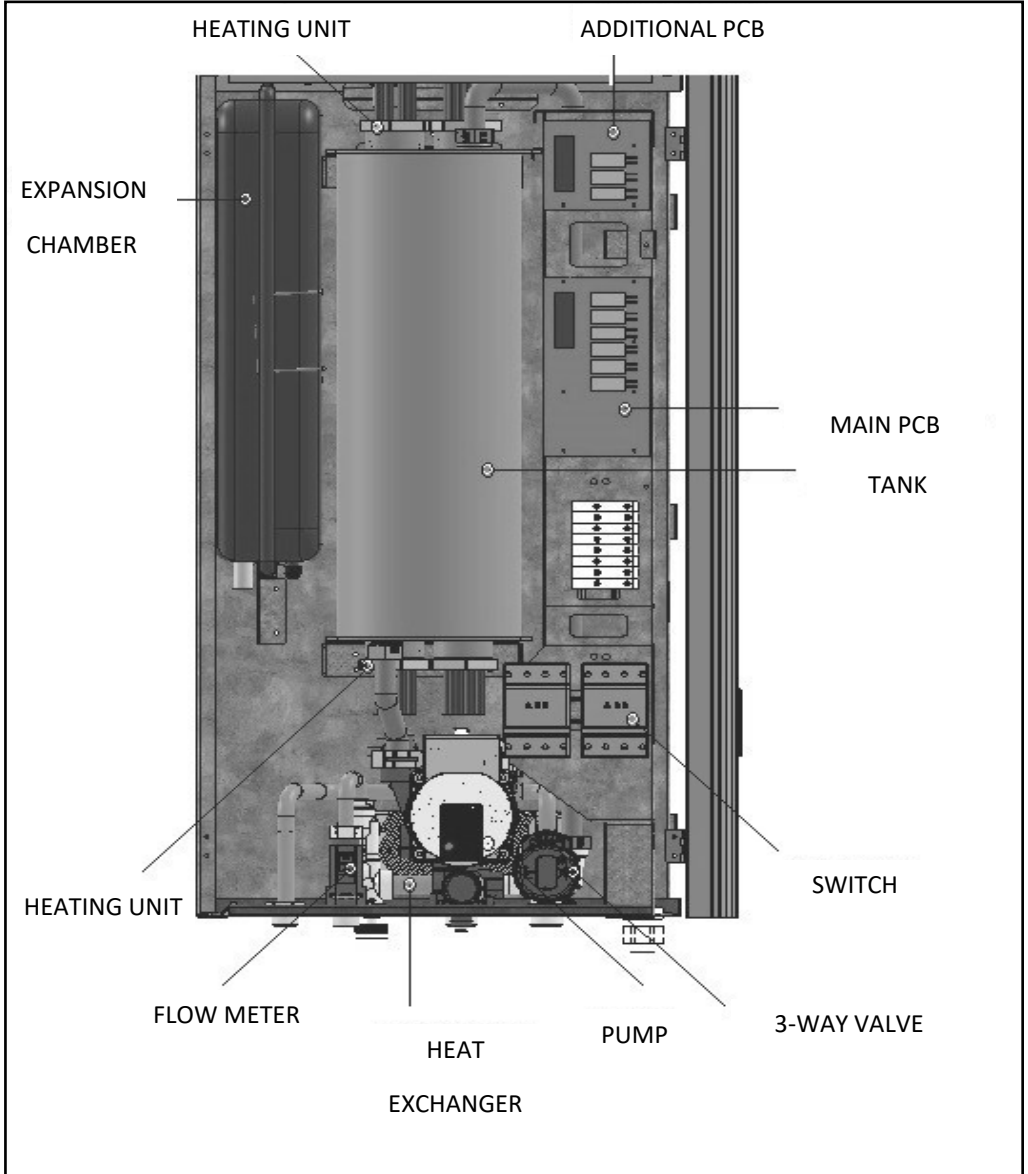

Using the UI on sanitary water preparation devices.

Each unit has a control panel that is used to control, change or adjust the device. The UI is examined in more detail on page 10. The same UI is used on the standard devices and the sanitary water preparation devices. The only difference are the parameters that can be changed.

1. Setting the desired water temperature:

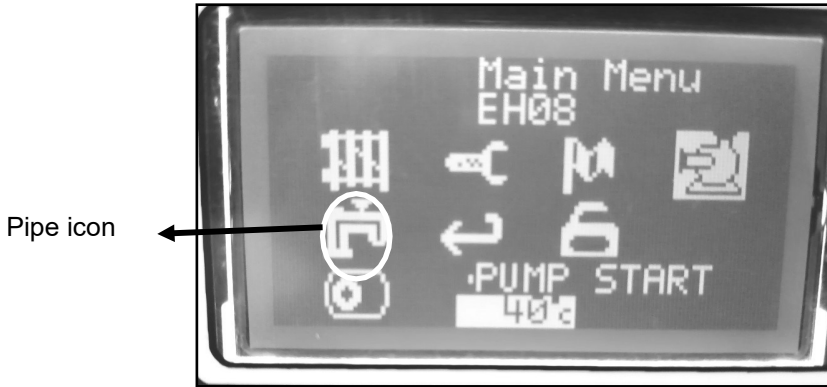

By selecting the icon, you set the desired temperature by pressing „+“ or „-“ keys. The unit is equipped with two sondes which control the temperature of the process.

One is located on the tank and the other is located on the heat exchanger. When the desired temperature is reached, the sonde reads the value and maintains it.

When the unit is operational during the winter and the room is being heated and you have a need for warm water, by opening the pipe the device transfers the flow from the heating circuit to the sanitary circuit and warm water is delivered momentarily.

When the unit is operational during the summer and there is no need for room heating so you want only warm water momentarily, the device runs in a manner that it wait for the pipe to open. Then the flow occurs (flow meter read), the unit turns on the pump and the 3-way valve, the heater units turn on and sanitary water circuit is open. Water temperature rises until the desired temperature is reached, the heater units turn off while the pump stays on until the flow is severed. Then it returns to standby.

8.3 ADJUSTING HEATING/ SANITARY WATER MODES

User interface is shown in the picture below:

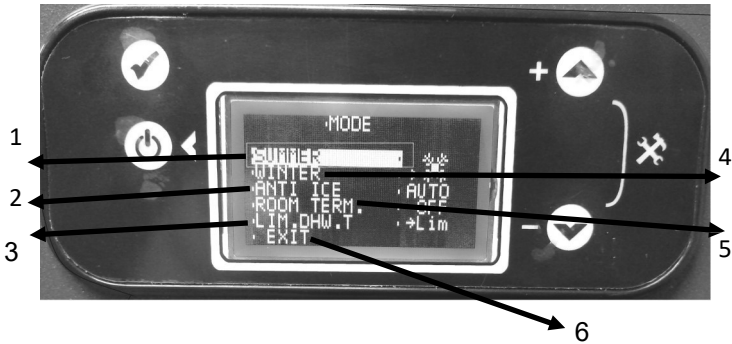

1— Mode set (SUMMER) - use when there is no need for room heating, only for warm water

2— ANTI ICE - turn ON or OFF the ANTI ICE feature (OFF— deactivated, AUTO— activated)

3—Used with the sperated tank. On the unit there is a heat exchanger so it has to be on „NO“

4—Mode set (WINTER) - use when there is a need for room heating (sanitary warm water always at the ready)

5—Set outer thermometer to ON or OFF - if connected, use „STOP“, if disconnected use „OFF“

6—Exit

NOTE: before any parameter change is done, it is necessary to use the LOCK icon and input the code „169“.

Otherwise, parameter change is not possible.

To ensure the unit operates as intended in the „SUMMER“ mode (sanitary warm water), in „PARAMETER 24“ the following conditions have to be met.



PRES: OFF or ON system pressure measuring (1-ON, 0-OFF)

RTSP: no longer in use (set to 0)

ICEP: OFF or ON anti ice control (1—ON, 0– OFF) - tank

ICED: OFF or ON anti ice cotrol (1– ON, 0– OFF) - sanitary water

TANK: extra tank sonde parameter (1– tank, 0– heat exchanger)

SYST: no longer in use

DHWO: flow component through the heat exchanger/ tank (pump or 3-way valve– in the unit it is the 3-way valve and the icon on the picture above)

t < 3C—ALRM—software version, DO NOT change

Pres—set minimal operational pressure under which, the unit is no longer operational

Bar: measured preasure in the system. (1-1,5 bar)

POWER VALUE	THERMAL EFFICIENCY	Flow (L) 12°C TO 38°C
15 kW	13,5 kW	7,5 l
18 kW	16,2 kW	8,9 l
21 kW	18,9 kW	10,4 l
22,5 kW	20,3 kW	11,2 l
24 kW	21,6 kW	11,9 l
28 kW	25,2 kW	13,9 l
30 kW	27 kW	14,9 l

8.4. WiFi CONTROL

WiFi control is setup very easily.

Download the “Proxel Connect” app from the App or Play store



Proxel Connect
Proxel Engineering Ltd

When finished downloading and installing, press the “CONNECT TO MODULE” button

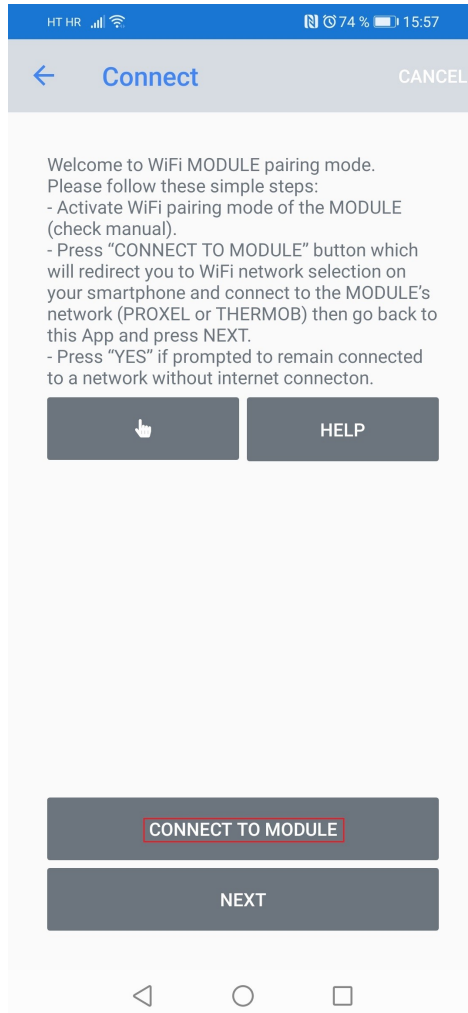

Find you WiFi device that begins with the name:

“Proxel xxx”



The connection password is located on the back of the control panel (display).

Open the front door of the device (unscrew the top and bottom screw).

Then select your router WiFi network and use your password for the selected network.

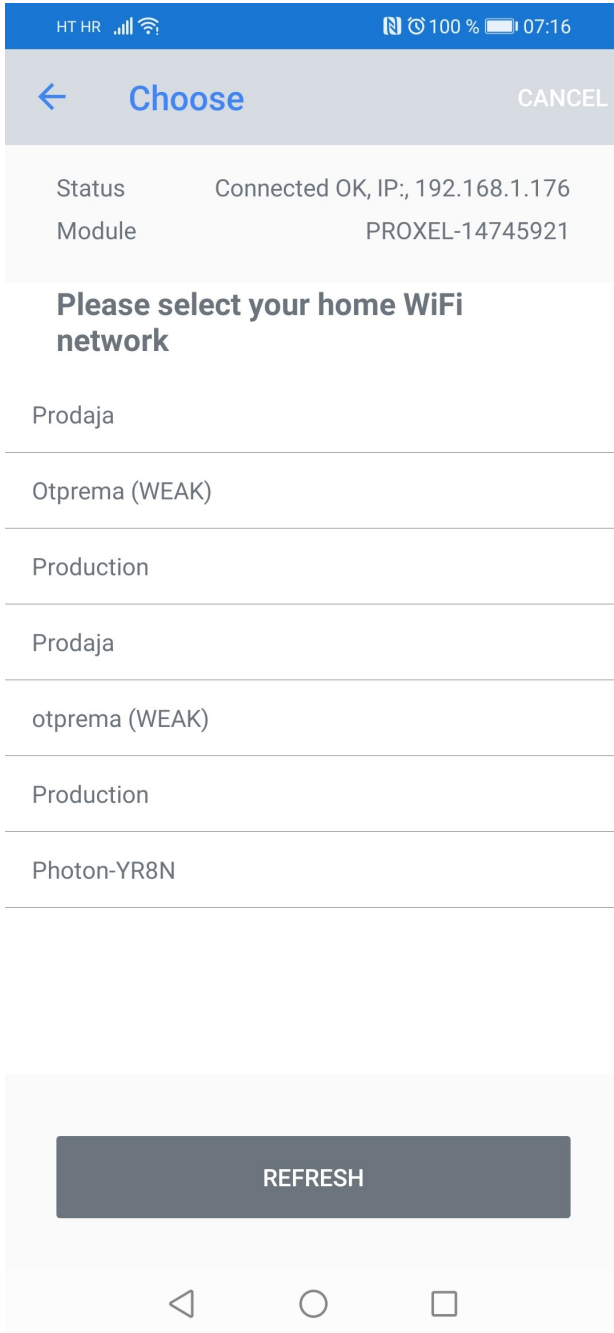

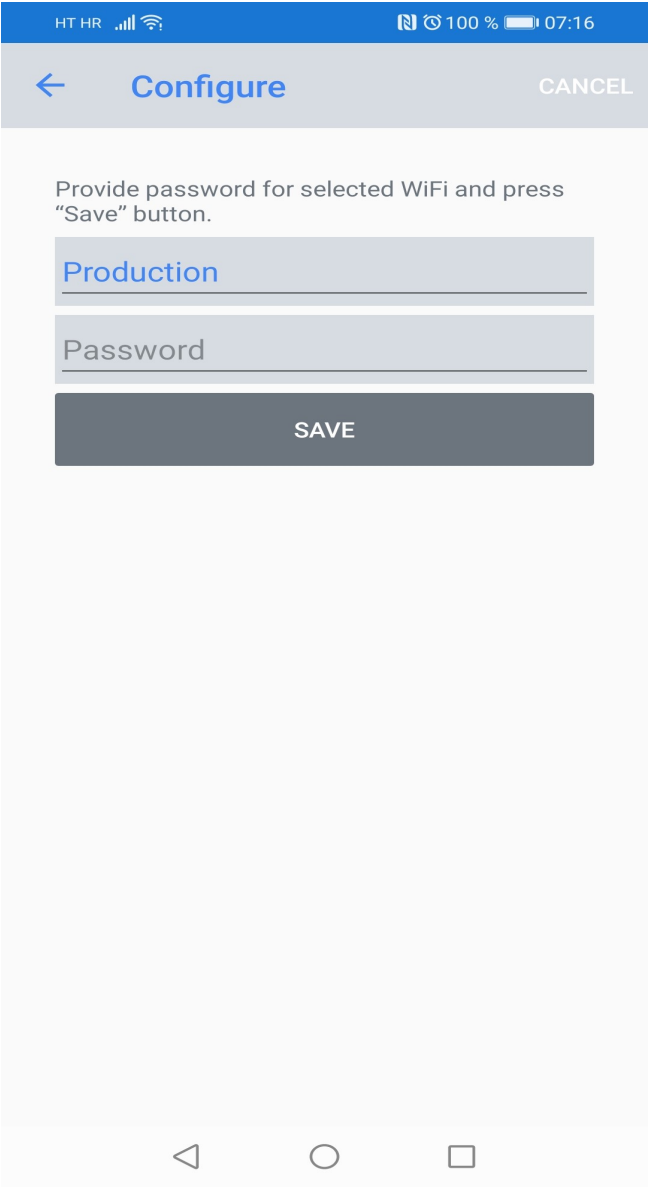

If the username and password are correct, you will get the window below.

Press DONE.

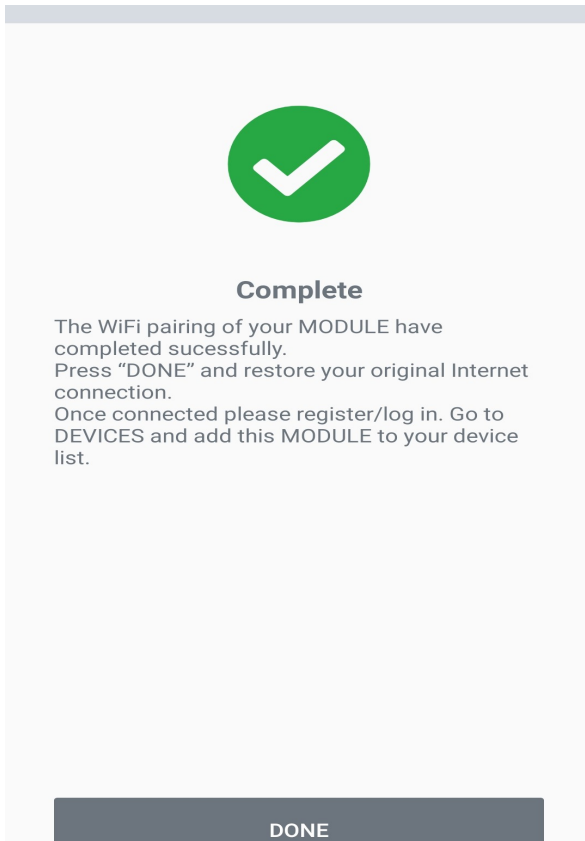







You have finished the device instalation.

Exit and re-enter the app

Continue with the sign up procedure



English  Български  Română 
Germany  Croatia  Slovenia 

Login

Username

Password

[Forgotten password?](#)

SIGN UP

LOGIN

Fill in your information.

HT HR 70% 15:57

web.proxel-bg.com/regis 2

Register

Username

Password

Name

E-mail

Phone

Description

I'm not a robot

reCAPTCHA
Pravila o privatnosti - Ujeti

After the previous step, you can now add the device.

Press „ADD DEVICE“.

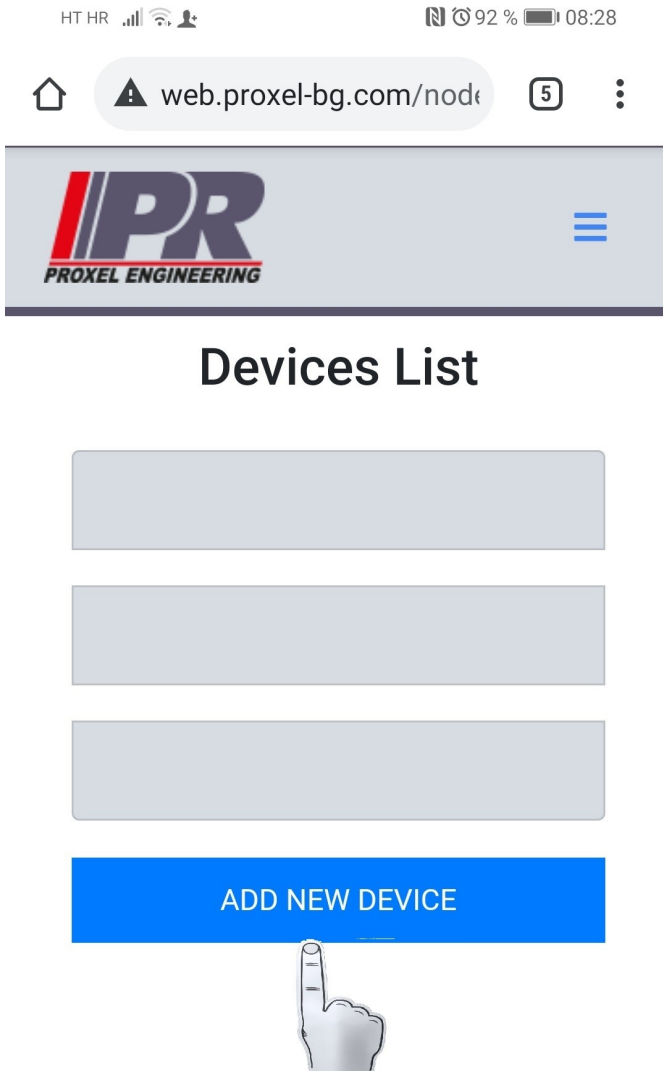

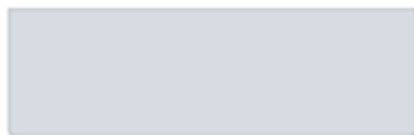
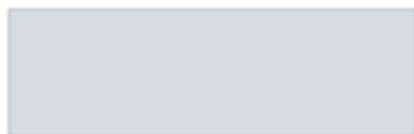
HT HR     92 %  08:28

Add new device

Device Id

Device Key

Device Name

CANCEL **SAVE**

Device ID and key are located
behind the display





After inputting the ID and password, which is usually the same as the ID, press „SAVE“.
Your device is now ready for using and you should see the window below

Hello

Status: OFF

TEMPERATURE



Set Point: 40 °C

MODE

11. TERMS OF WARRANTY

These warranty conditions are valid in all European countries, in which SENKO products are sold. The client addresses the manufacturer/dealer or the nearest authorized servicing agent for all complaints; providing the purchase receipt with the date of purchase, warranty and installation report in the process.

DURATION OF THE WARRANTY

Manufacturer SENKO d.o.o. provides a 2-year warranty for its product, starting from the date of embedded boiler purchase. All other parts (thermometer, automatic regulator with the probe, regulation buttons) have a 6-months warranty.

The manufacturer guarantees that the product was manufactured and certified according to the EN 12815 norm and that it complies with all the demands set by the norm. The user is obligated to adhere to the Instruction manual.

EXCEPTIONS

Exceptions are parts subject to wear such as chamotte and chamotte plates, firebox grate, ash box, seals and glass panes.

Chamotte plates (changes in colour or cracks are dependent on the material and can never be completely ruled out). However, they do not impair the functioning of the appliance (as long as the plates remain in the firebox) and they are not a motive for complaint.

Glass (door, panels, CERAN cooking plate) - breakage or damage of the glass because of external hazard, changes on the surface due to thermal influences such as fly-ash or soot at the surface of the glass.

Discolouring of paint due to overload of thermal strain.

Seals - e.g. hardening or breakage due to thermal or mechanical strain.

Surface coatings - frequent cleaning or cleaning with abrasive cleaning agents.

Castings and parts which are subject to high thermal stress - firebox grate, cooking plate or ashbox.

Heat exchanger (boiler) is not subject to the warranty in the event in which it is not secured with adequate anti-condensate circuit which guarantees a minimum return water temperature of at least 55°C.

REPAIRS

Possible repairs within the warranty will be executed within 30 days from the date of product delivery to the manufacturer. Should the repairs not be executed within 30 days from the delivery to the manufacturer, the product will be replaced with a new one. The manufacturer will notify the client about the executed repairs. The client is obligated to take over the product within 5 days from the repair completion.

COSTS

The manufacturer does not defray any delivery and return costs.

Prior to commencement of repairs within the warranty (for damages caused by incorrect use, cooker transport and mounting), the manufacturer will notify the client about the repair price in written form. Once the client agrees, the manufacturer will execute the repairs and charge the client for the repairs.

SPARE PARTS

Original parts replaced within the warranty do not have to match the removed parts in external physical appearance, but they must match them in quality and functionality.

DISCLAIMER OF LIABILITY

Manufacturer cannot accept any liability for the loss or the damage of an appliance through theft, fire, vandalism or similar causes. Indirect or direct damage caused to the product, which is the result of improper transportation of the product, are excluded from the liability. We cannot accept any liability for damages caused by chemical or electrochemical effects (e.g. pollutants in the combustion air, water scale and similar) which are the result of improper installation of the product and violation of this instruction manual.

ADDITIONAL TERMS

Small dimensional differences in construction materials and parts of the cooker are not a reason for complaint. During the period in which the product was inefficient, we will not grant any compensation. This warranty applies only to the customer specified in the warranty sheet and cannot be transferred to others.

The warranty is void if the user made alterations to the product without manufacturer's prior knowledge. If the user was negligent and performed maintenance on the wrong way. If the user is using fuel that is not compliant with the types and quantities indicated in this Manual.

The warranty is valid if the installation was executed by an authorized professional and upon presenting the written installation report.

Possible disputes to be settled by the competent Court in Čakovec.

WARRANTY No.

SERIAL NUMBER: _____

DATE OF MANUFACTURE: _____

STORENAME AND ADDRESS: _____

CLIENT NAME AND ADDRESS: _____

DATE OF PURCHASE: _____

STORESTAMP AND DEALER SIGNATURE: _____

Complaints within warranty – product information

Malfunction description (client):

Servicing agency comments:

Servicing completed on date:

Stamp and servicing technician signature: _____

Malfunction description (client):

Servicing agency comments:

Servicing completed on date:

Stamp and servicing technician signature: _____

SENKO

Vladimira Nazora 22, Štefanec, 40000 Čakovec, Hrvatska
Tel: +385 (0)40 33 73 44 • E-mail: info@senko.hr

www.senko.hr

facebook.

You Tube



We reserve the right to change all pictures, technical details and colours of products, mentioned in this manual, without prior notice.